

# Scotsman Ice Systems

## Installation and Operating Instructions

### MXG 327 / 437 / 638 Models

#### Important Information

This equipment must be installed in accordance with all local, state, and national regulations. This machine must be installed correctly as per these installation instructions. **This machine must be installed by a qualified Refrigeration or Electrical technician. A plumber should only be used to make the water connections.**

#### **THIS MACHINE IS NOT DESIGNED FOR OUTDOOR USE**

**LOCATION** - This ice machine must be level and situated in a cool dry area with sufficient air ventilation. **The ice machine is NOT to be installed in a cupboard or with limited or restrictive airflow. The equipment should NOT be located next to equipment that discharges or radiates hot air on or near the ice machine. NOTE: Hotter working environments OR water temperatures will reduce the production capacity of the machine.**

#### Operating Specifications Below

<b>Operating air temperatures</b>	<b>Min 10°C to Max 40°C (24°C ideal)</b>
<b>Operating water temperatures</b>	<b>Min 5°C to Max 35°C (18°C ideal)</b>
<b>Operating water pressure</b>	<b>Min 1 bar to Max 5 bar</b>
<b>Machine side clearance</b>	<b>Min 150mm</b>
<b>Machine rear clearance</b>	<b>Min 100mm</b>

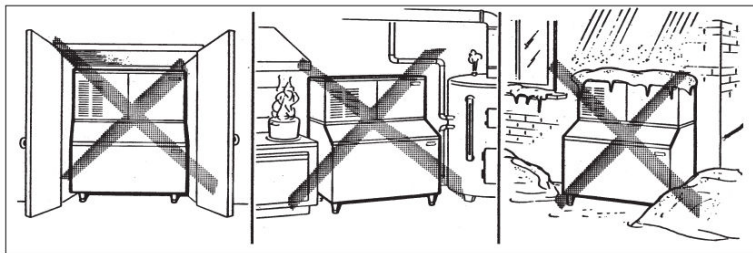

A water filter system must be fitted to the ice machine, this will help to reduce and control the buildup of sediment, scale, mineral and bacteria from accumulating inside the machine. The location should have a dedicated power point, a dedicated constant water supply and a water drainage point all within one meter of the machine.

**For the ice maker to operate effectively and efficiently the machine requires sufficient air ventilation around the machine. It requires a Minimum side clearance of 150mm and a Minimum rear clearance of 100mm.**

**Contact Moffat Service Support On 1300 264 217 For Assistance**

**Set Up** After unboxing the machine inspect for damages. Fit the ice machine head to the ice storage bin and secure it with the screws provided. Pull the black plastic trim from the top of the ice machine head. Unscrew and open the front and top panels, remove the manuals, hoses, packaging. Fit the water supply hose to the water inlet valve on the back of the machine. Fit the water drain hose and clip to water outlet pipe on the back of machine. Connect the opposite end of the water supply hose to the water filter outlet. Attach the opposite end of the water drain hose to the floor drain or tundish. Remove the ice bin sensor and stainless-steel bracket from the electrical area, remove the black rubber bung from the electrical area and place the sensor through the hole into the ice bin. Remove the plastic ice chute from the food

zone of the ice machine. Bring the sensor through the ice chute hole and fix the sensor and the sensor protector ends to the bracket as in the photo attached using the plastic screw clips and screws provided in the service manual.

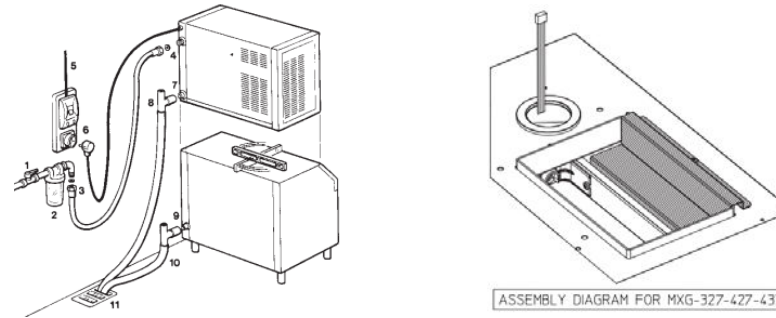

Fix the sensor to the ice machine head inside the ice bin chute hole and secure it with a single screw in the center of the bracket. Gently pull the excess sensor wire into the electrical panel area. Cut a slot in the rubber bung for the electrical sensor wire and re-fit the rubber bung. Fit the ice chute back to the machine and the front and top panels. Re-fit the front plastic trim panel and remove the protective plastic from the outside of the ice machine.

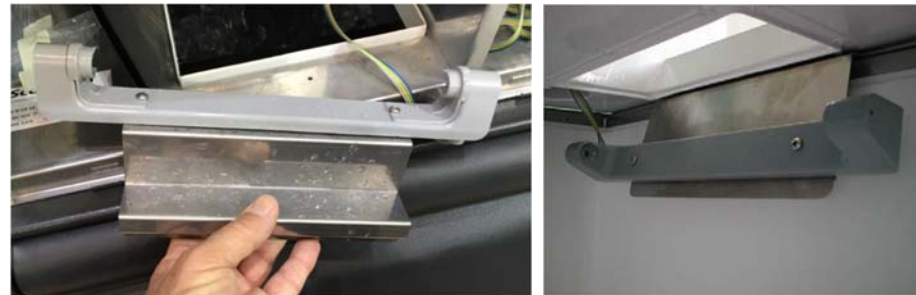

Maneuver the machine into its final position. **ENSURE THE MACHINE HAS THE REQUIRED SIDE AND REAR VENTILATION CLEARANCES.**

#### Electrical Connections

The electrical connections for this machine must comply with all local, state and national regulations. The ice maker requires a dedicated power point. Check the serial plate to ensure voltage requirements and plug are suitable for the wall socket and power supply for your local area. All electrical connections and adjustments must be undertaken by a qualified technician.

#### 12 Point Checklist

- 1) Is the ice maker level?
- 2) Is the ambient air temperature between 10c and 40c?
- 3) Is there the required 150mm side clearance and 100mm rear clearance? check there is NO other equipment next to the unit discharging hot air near or onto the machine?
- 4) Have the water connections been made and checked? Is the water pressure between 1 and 5 bars? Has the water pressure been tested?
- 5) Is the incoming water temperature between 5C and 35C? (optimum water temp should be between 15c to 21c)
- 6) Does the machine have a 3-stage water filter fitted?
- 7) Do the electrical requirements comply and has the electrical connection been made? DO NOT TURN ON THE MACHINE.
- 8) Has everything been removed from inside the ice machine?
- 9) Has the ice bin shut off components / system been fitted correctly?
- 10) Has the owner been instructed on the operation and maintenance of the machine? Has the owner been given the installation instructions which include the maintenance details?
- 11) Has the machine been cleaned and sanitized before starting up?
- 12) Does the customer have Moffat's service contact details?

#### Start Up

- 1) Open the water supply to the ice machine and check for water leaks.
- 2) Switch the power on at the wall socket and press the green light switch button on the front of the machine.
- 3) The machine will enter the startup cycle for 5 minutes filling the water trough. You will hear water trickling into the water trough.
- 4) After the 5-minute filling / draining cycle is completed, the machine will start up in the freezing cycle (Yellow light) The refrigeration system will run, and the condenser fan will thermostat on and off during the cycle. The machine will run for between 24 to 30 minutes making ice (depending on ambient and water temperatures)
- 5) Once the ice is made and fully formed, the machine will go into a harvest cycle until all the ice cubes have dropped into the ice storage bin.
- 6) When the ice bin is full, ice will block the bin shut of sensor and will shut the ice machine down (Yellow light)
- 7) When ice is removed from the bin and the ice level drops, the machine will re- start after a 3 x minute delay.
- 8) After the machine has completed 4 cycles, open the ice storage bin, and inspect the freshly made ice cubes. They should have a small indentation at the bottom of the cube like in diagram below.

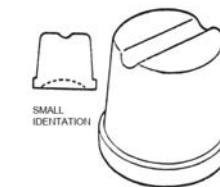

**Contact Moffat Pty Ltd on 1300 264 217 for assistance with the installation**

## Maintenance, Cleaning and Sanitizing Instructions

To ensure your Scotsman ice machine operates effectively, efficiently and in peak performance, the ice machine requires regular maintenance, cleaning, and sanitizing. **As per Health and Safety requirements in Australia, it is the owner's responsibility to ensure the ice machine is installed, maintained, and regularly cleaned as per the manufacturer's specifications. Ice is classed as a food product so the machine must be regularly inspected and maintained to ensure the ice is clean, safe and fit for human consumption.**

### Cleaning Schedules

**All Scotsman ice machines require a general clean and sanitize procedure every two weeks to a month (depending on the location of the machine)**

**All Scotsman ice machines require a major strip down, a deep clean and sanitizing twice a year by a qualified technician (depending on the location of the machine it may require more frequent cleaning)**

### General Weekly or Monthly Clean

Shut down the machine, remove the air filter element and inspect and clean with a soft bristle brush or wash air filter with warm soapy water and dry, replace the air filter. **(Regularly wipe down and clean the ice bin level sensors)**

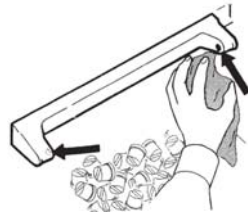

Clean the inside of the ice bin thoroughly with a cleaner and then rinse off. Sanitize the ice bin using Moffat ice machine sanitizer and then rinse off with water. **Pour 1 liter of warm water and Moffat ice machine sanitizer down the ice bin drain to keep drain and drain hoses clean and free of bacteria. (Mixture 10 parts water and 1 part Moffat ice machine sanitizer)** Wipe down and clean the outside of the ice machine cabinet and clean the ice bin door using disposable sanitizing wipes. Check the machine has the required 150mm side and 100mm rear clearance for maximum air ventilation. Check the water filter is not blocked and that the general area around the machine is clean and tidy. Turn the ice machine back on and discard the first 2 x batches of ice. Inspect the quality of the ice after two drops.

### Six Month Major Strip Down and Deep Clean

**A major strip down deep clean should only be performed by a qualified technician.**

At the end of the harvest cycle shut down the ice machine. Remove ALL the ice from the ice storage bin. Remove the air filter element, remove the top, front and both side panels of the machine. Inspect and clean the air filter element with a soft bristle brush or wash with warm soapy water and rinse if required and allow to dry. Inspect the condenser area and condenser, clean with a soft brush or vacuum gently if needed. Reach into the food zone and lift-up and remove the water spray bar and washer. Using a bucket mix up a solution of warm water and Moffat nickel safe cleaner, wash all the components thoroughly and then rinse off and then sanitize. Rinse off all parts with water thoroughly and dry.

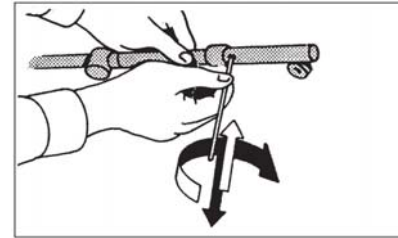
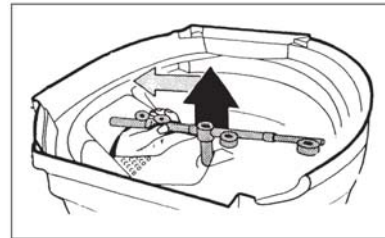

Using a pin or pointed object, clean the spray nozzles and spray jet that spin the spray bar. Reassemble the food zone components and re-fit the water spray bar.

Mix 2 liters of water with 200mls of **Moffat's nickel safe ice machine cleaner**, remove the white evaporator plastic cover and slowly pour the cleaning solution over the top of the evaporator. Using a soft bristle brush, gently clean the evaporator on both sides (inside and outside) Do NOT use anything abrasive that may damage the nickel plating. (repeat for multi evaporator machines - MXG-638-938)

### WARNING

**Only use Moffat's Nickel Safe ice machine cleaner for all Scotsman ice machines. Using a non-nickel safe cleaner will DAMAGE the nickel-plating on the evaporator.**

Restart the ice machine and press the CLEAN button for more than 2 seconds but less than 5 seconds. The machine will go into the clean mode, let the machine run for 20 minutes to clean the food zone and water system and then shut the machine down. Drain the cleaning solution out of the food zone / water trough through the insulated black pipe as in the below diagram.

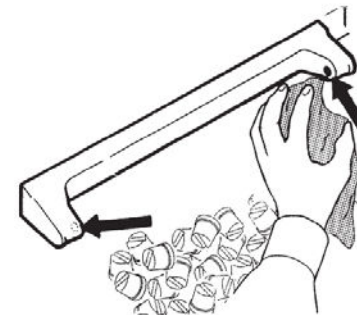

Pour 2 to 3 liters of fresh water over the top of the evaporator and allow to rinse the evaporator into the food zone. Restart the machine and allow the machine to run for 10 minutes to rinse off the food zone. Repeat this last rinsing step two times to ensure the machine is clean and free of the cleaning solution.

Repeat the process using a mixture of warm water and sanitizer. Re-start the machine and press the CLEAN button for more than 2 seconds but less than 5 seconds. The machine will go into the clean mode, let the machine to run for 10 minutes to sanitize the food zone and water system and then shut down. Allow the sanitizing solution to drain out the food zone. Rinse off the water through, food zone and ice storage bin with fresh water. Wipe down and clean the ice bin level sensors. Reassemble the ice machine and double check all parts are re-fitted correctly.

**Moffat's Sanitizer mixture – 1 x liter of water to - 100 ml sanitizer ( 10 parts to 1 )**

Wipe down the outside of the machine cabinet and storage bin using disposable cleaning wipes. Pour the remainder of the water / sanitizer down the ice bin drain to keep the drain and drain hose clean and free of bacteria. Allow the machine to make 2 x batches of ice and inspect the ice cubes. Discard the first 2 drops of ice to ensure the ice is clean and free of any cleaner or sanitizer.

### Ice Machine Fault Finding Check List

For ice machine fault finding, first check the **12 Point Checklist** in this manual, then check below points before calling Moffat Service.

**Slow production** - check water tap is on full, check the water filter strainer is clean on the inlet valve (remove hose to check) check water filter is clean. Is there any equipment generating heat next to the machine? (refrigerators, dishwashers, fryers, ovens) Check there is cool air ventilation around the machine.

**Deformed ice cubes** – check water spray system is fitted correctly; check spray nozzles are clean and not blocked. Has the machine had regular cleaning and sanitizing? when last was the machine striped and cleaned professionally?

**Water Leaks** – Has the machine been sanitized regularly? A dirty blocked up machine will cause water leaks, check water filter, water hoses and drain hoses for water leaks. Check the drain hose is securely located in a vented drain or tundish.

**Ice machine error codes are located inside the front door panel.**

### How an Ice Machine Works

An ice machine works by transferring heat from the water inside the ice machine, to the condenser through the refrigeration system. The condenser fan exhausts this heat out and away from the ice machine. The transfer of heat is so efficient that it freezes the water into the evaporator mold making ice cubes.

NOTE: If the airflow is restricted or blocked on either the air inlet or air outlet vents the heat transfer process will not take place. This means the ice machine will make little or no ice. It requires good cool airflow through the machine to operate effectively and efficiently.

Ensure there is NO heat generating equipment next to or close by the ice machine. The hotter the work area and water temperature is, the less ice the machine will make.

### Warranty Details, terms and conditions

Warranty issues are all subject to Moffat Pty Ltd.'s standard terms and conditions. To view Moffat's terms and conditions, please visit the Moffat web site on [www.moffat.com.au](http://www.moffat.com.au)